

MADE IN CHINA

The logo for TOSOT, featuring the brand name in a bold, black, sans-serif font. The letter 'O' is stylized with a white lightning bolt or starburst shape inside it. The logo is positioned on the right side of the cover, partially overlapping a large, curved, light gray graphic element that sweeps across the page from the bottom left towards the top right.

**TOSOT**

OWNER'S MANUAL

TU18HFI  
TU24HFI  
TU30HFI  
TU36HFI  
TU42HFI  
TU48HFI

TU18H3O  
TU24H3O  
TU30H3O  
TU36H3O  
TU42H3O  
TU48H3O

# To Users

Thank you for selecting TOSOT's product. Please read this instruction manual carefully before installing and using the product, so as to master and correctly use the product. In order to guide you to correctly install and use our product and achieve expected operating effect, we hereby instruct as below:

- (1) This appliance is not intended for use by persons (including children) with reduced physical, sensory or mental capabilities, or lack of experience and knowledge, unless they have been given supervision or instruction concerning use of the appliance by a person responsible for their safety. Children should be supervised to ensure that they do not play with the appliance.
- (2) In order to ensure reliability of product, the product may consume some power under stand-by status for maintaining normal communication of system and preheating refrigerant and lubricant. If the product is not to be used for long, cut off the power supply; please energize and preheat the unit in advance before reusing it.
- (3) Please properly select the model according to actual using environment, otherwise it may impact the using convenience.
- (4) This product has gone through strict inspection and operational test before leaving the factory. In order to avoid damage due to improper disassembly and inspection, which may impact the normal operation of unit, please do not disassemble the unit by yourself. You can contact with the special maintenance center of our company if necessary.
- (5) When the product is faulted and cannot be operated, please contact with our maintenance center as soon as possible by providing the following information.
  - 1)Contents of nameplate of product (model, cooling/heating capacity, product No., ex-factory date).
  - 2)Malfunction status (specify the situations before and after the error occurs).
- (6) All the illustrations and information in the instruction manual are only for reference. In order to make the product better, we will continuously conduct improvement and innovation. We have the right to make necessary revision to the product from time to time due to the reason of sales or production, and reserve the right to revise the contents without further notice.



- (7) The final right to interpret for this instruction manual belongs to TOSOT.

## Exception Clauses

Manufacturer will bear no responsibilities when personal injury or property loss is caused by the following reasons:

- (1) Damage the product due to improper use or misuse of the product;
- (2) Alter, change, maintain or use the product with other equipment without abiding by the instruction manual of manufacturer;
- (3) After verification, the defect of product is directly caused by corrosive gas;
- (4) After verification, defects are due to improper operation during transportation of product;
- (5) Operate, repair, maintain the unit without abiding by instruction manual or related regulations;
- (6) After verification, the problem or dispute is caused by the quality specification or performance of parts and components that produced by other manufacturers;
- (7) The damage is caused by natural calamities, bad using environment or force majeure.

# Contents

1 Safety Precautions.....	1
2 Outline of the Unit and Main Parts.....	3
3 Preparative for Installation .....	4
3.1 Standard Accessory Parts.....	4
3.2 Selection of the Installation Location.....	5
3.3 Connection Pipe Requirement .....	7
3.4 Electrical Requirement .....	8
4 Installation of the Unit .....	9
4.1 Installation of the Indoor Unit.....	9
4.2 Installation of the Outdoor Unit.....	12
4.3 Installation of the Connection Pipe.....	13
4.4 Vacuum and Gas Leakage Inspection .....	17
4.5 Installation of the Drain Hose .....	19
4.6 Installation of the Duct.....	23
4.7 Electrical Wiring.....	25
5 Installation of Controllers .....	29
6 Test Running .....	30
6.1 Trial Operation and Testing.....	30
6.2 Working Temperature Range .....	32
7 Unit Function.....	33
7.1 Setting of Double Indoor Room Sensors.....	33
7.2 Checking of Outdoor Ambient Temperature .....	33
7.3 Fresh Air Control .....	34
8 Troubleshooting and Maintenance.....	34
8.1 Troubleshooting.....	34
8.2 Routine Maintenance.....	35

# 1 Safety Precautions

	This is the safety alert symbol. It is used to alert you to potential personal injury hazards. Obey all safety messages that follow this symbol to avoid possible injury or death.
<b>⚠WARNING</b>	This mark indicates procedures which, if improperly performed, might lead to the death or serious injury of the user.
<b>⚠CAUTION</b>	This mark indicates procedures which, if improperly performed, might possibly result in personal harm to the user, or damage to property.
<b>NOTICE</b>	NOTICE is used to address practices not related to personal injury.

<b>⚠WARNING</b>	
(1).	This product can't be installed at corrosive, inflammable or explosive environment or the place with special requirements, such as kitchen. Otherwise, it will affect the normal operation or shorten the service life of the unit, or even cause fire hazard or serious injury. As for above special places, please adopt special air conditioner with anti-corrosive or anti-explosion function.
(2).	Instructions for installation and use of this product are provided by the manufacturer.
(3).	Installation must be performed in accordance with the requirements of NEC and CEC by authorized personnel only.
(4).	For operating the air conditioner pleasantly, install it as outlined in this installation manual.
(5).	Connect the indoor unit and outdoor unit with the room air conditioner piping and cord available from our standard parts. This installation manual describes the correct connections using the installation set available from our standard parts.
(6).	Installation work must be performed in accordance with national wiring standards by authorized personnel only.
(7).	If refrigerant leaks while work is being carried out, ventilate the area. If the refrigerant comes in contact with a flame, it produces toxic gas.
(8).	Do not power on until all installation work is complete.
(9).	During installation, make sure that the refrigerant pipe is attached firmly before you run the compressor. <ul style="list-style-type: none"> <li>● Do not operate the compressor under the condition of refrigerant piping not attached properly with 2-way or 3-way valve open.</li> <li>● This may cause abnormal pressure in the refrigeration cycle that leads to breakage and even injury.</li> </ul>
(10).	During the pump-down operation, make sure that the compressor is turned off before you remove the refrigerant piping. <ul style="list-style-type: none"> <li>● Do not remove the connection pipe while the compressor is in operation with 2-way or 3-way valve open.</li> <li>● This may cause abnormal pressure in the refrigerant cycle that leads to breakage and even injury.</li> </ul>
(11).	When installing and relocating the air conditioner, do not mix gases other than the specified refrigerant (R410A) to enter the refrigerant cycle. <ul style="list-style-type: none"> <li>● If air or other gas enters the refrigerant cycle, the pressure inside the cycle will rise to an abnormally high value and cause breakage, injury, etc.</li> </ul>

**⚠ WARNING**

- |   |
|---|
| (12). This appliance is not intended for use by persons (including children) with reduced physical, sensory or mental capabilities, or lack of experience and knowledge, unless they have been given supervision or instruction concerning use of the appliance by a person responsible for their safety. |
| (13). Children should be supervised to ensure that they do not play with the appliance.   |
| (14). If the supply cord is damaged, it must be replaced by the manufacturer, its service agent or similarly qualified persons in order to avoid a hazard.  |



## 2 Outline of the Unit and Main Parts

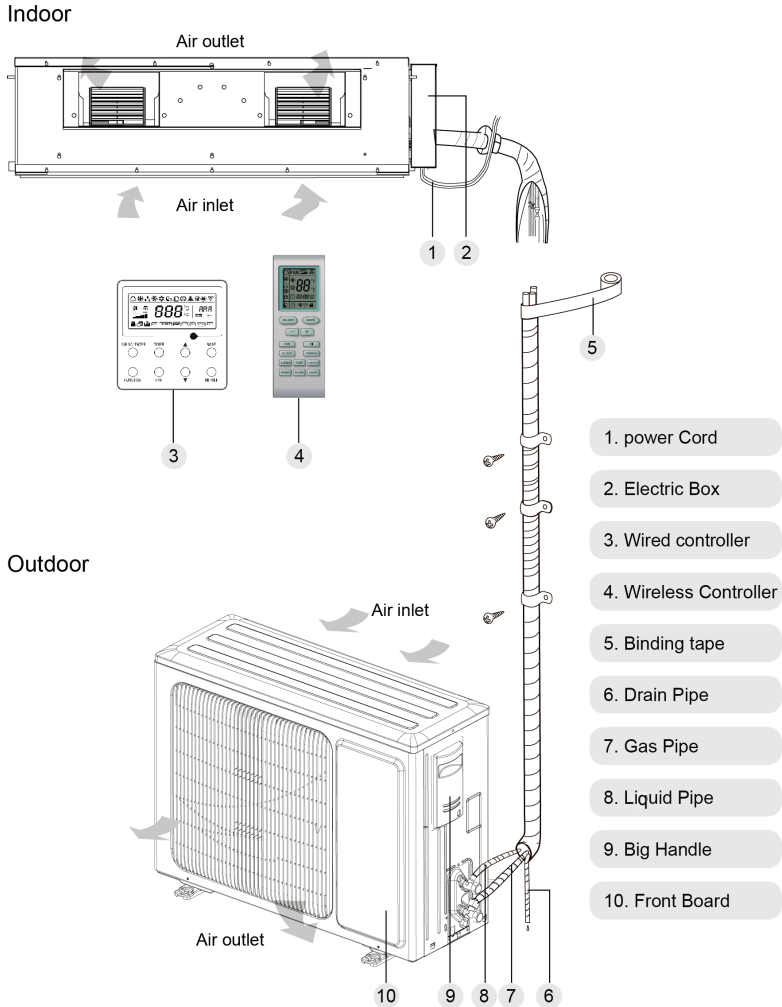

Fig. 2.1

### NOTICE









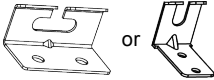

- ①. The connection pipe, drain pipe, power cord, and duct for this unit should be prepared by the user.
- ②. The unit is standard equipped with rectangular duct.

## 3 Preparative for Installation

### 3.1 Standard Accessory Parts

The standard accessory parts listed below are furnished and should be used as required.

Table 3.1

Indoor Unit Accessories				
No.	Name	Appearance	Q'ty	Usage
1	Wired Controller		1	To control the indoor unit
2	Screw		2	To fix the base plate of wired controller and installation hole of the wall together
3	Hanger		4	To fix the indoor unit(except for TU36HFI TU42HFI)
4	Screw		4	To fix the hook on the cabinet of the unit. (apply to TU48HFI)
5	Nut with Washer		8	To fix the hook on the cabinet of the unit. (apply to TU18HFI TU24HFI TU30HFI)
6	Nut with Washer		4	To be used together with the hanger bolt for installing the unit
7	Nut		4	To be used together with the hanger bolt for installing the unit
8	Washer		4	To be used together with the hanger bolt for installing the unit
9	Insulation		1	To insulate the gas pipe
10	Insulation		1	To insulate the liquid pipe
11	Fastener		4	To fasten the sponge





Indoor Unit Accessories				
No.	Name	Appearance	Q'ty	Usage
12	Sponge		2	To insulate the drain pipe
13	Nut		1	To connect liquid pipe
14	Nut		1	To connect gas pipe

Table 3.2

Outdoor Unit Accessories				
No.	Name	Appearance	Q'ty	Usage
1	Drain Plug		1 or 3	To plug the unused drain hole
2	Drainage Connector		1	To connect with the hard PVC drain pipe

## 3.2 Selection of the Installation Location

### **⚠ WARNING**

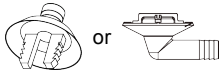
- ①. The unit must be installed where strong enough to withstand the weight of the unit and fixed securely, otherwise the unit would topple or fall off.
- ②. Do not install where there is a danger of combustible gas leakage.
- ③. Do not install the unit near heat source, steam, or flammable gas.
- ④. Children under 10 years old must be supervised not to operate the unit.

Decide the installation location with the customer as follows:

### 3.2.1 Indoor Unit

- (1). Install the unit at a place where is strong enough to withstand the weight of the unit.
- (2). The air inlet and outlet of the unit should never be clogged so that the airflow can reach every corner of the room.
- (3). Leave service space around the unit as required in Fig. 3.1.

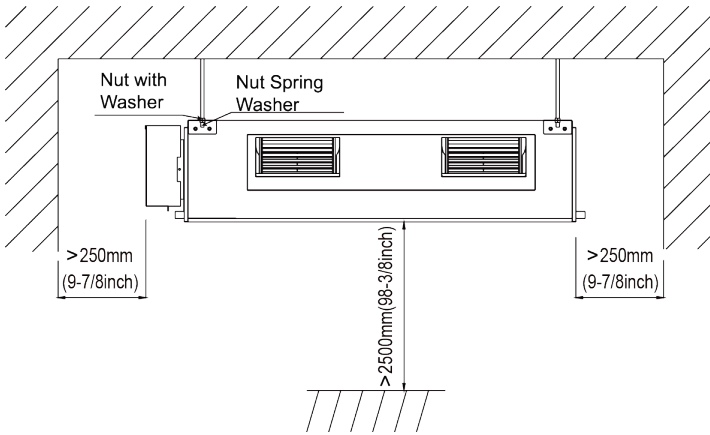

Fig. 3.1

- (4). Install the unit where the drain pipe can be easily installed.
- (5). The space from the unit to the ceiling should be kept as much as possible so as for more convenient service.

### 3.2.2 Outdoor Unit

**▲WARNING**

- |  |
|--|
| ①. Install the unit where it will not be tilted by more than 5°.   |
| ②. During installation, if the outdoor unit has to be exposed to strong wind, it must be fixed securely. |

- (1). If possible, do not install the unit where it will be exposed to direct sunlight. (If necessary, install a blind that does not interfere with the air flow.)
- (2). Install the outdoor unit in a place where it will be free from getting dirty or getting wet by rain as much as possible.
- (3). Install the outdoor unit where it is convenient to connect the indoor unit.
- (4). Install the outdoor unit where the condensate water can be drained out freely during heating operation. Do not place animals and plants in the path of the warm air.
- (5). Take the air conditioner weight into account and select a place where noise and vibration are small.
- (6). Install the outdoor unit where is capable of withstanding the weight of the unit and generates as less noise and vibration as possible.
- (7). Provide the space shown in Fig. 3.2, so that the air flow is not blocked. Also for efficient operation, leave three of four directions of peripheral constructions open.

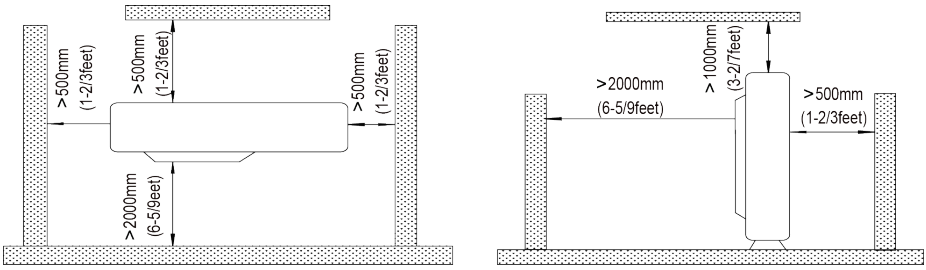

Fig. 3.2

### 3.3 Connection Pipe Requirement

**⚠ CAUTION**

The maximum length of the connection pipe is listed in the table below. Do not place the units between which the distance exceeds the maximum length of the connection pipe.

Table 3.3

Model \ Item	Size of Fitting Pipe mm (inch)		Max. Pipe Length m (feet)	Max. Height Difference between Indoor Unit and Outdoor Unit m (feet)	Drainage pipe(Outer Diameter × wall thickness) mm (inch)
	Liquid	Gas			
TU18HFI TU18H3O	6(1/4)	12.7(1/2)	50(164)	15(49-1/5)	Φ30×1.5 (Φ1-1/8×3/50)
TU24HFI TU24H3O	9.5(3/8)	16(5/8)	50(164)	15(49-1/5)	Φ20×1.2 (Φ3/4×6/125)
TU30HFI TU30H3O	9.5(3/8)	16(5/8)	50(164)	15(49-1/5)	Φ20×1.2 (Φ3/4×6/125)
TU36HFI TU36H3O	9.5(3/8)	16(5/8)	50(164)	15(49-1/5)	Φ20×1.2 (Φ3/4×6/125)
TU42HFI TU42H3O	9.5(3/8)	16(5/8)	50(164)	15(49-1/5)	Φ20×1.2 (Φ3/4×6/125)
TU48HFI TU48H3O	9.5(3/8)	16(5/8)	70(230)	15(49-1/5)	Φ20×1.2 (Φ3/4×6/125)

**Notes:**

- ①. The connection pipe should be insulated with proper water-proof insulating material.
- ②. The pipe wall thickness shall be 0.5~1.0mm (1/50~1/25inch) and the pipe wall

shall be able to withstand the pressure of 6.0MPa (870psig). The longer the connecting pipe, the lower the cooling and heating effect performs.

### 3.4 Electrical Requirement

Electric Wire Size and Fuse Capacity.

Table 3.4

Indoor Units	Power Supply	Fuse Capacity	Minimum Circuit Ampacity	Maximum Overcurrent Protection
	V/Ph/Hz	A	A	A
TU18HFI	208V/230V ~60Hz	5	1	15
TU24HFI	208V/230V ~60Hz	5	2	15
TU30HFI	208V/230V ~60Hz	5	2	15
TU36HFI	208V/230V ~60Hz	5	3	15
TU42HFI	208V/230V ~60Hz	5	3	15
TU48HFI	208V/230V ~60Hz	5	5	15

Table 3.5

Outdoor Units	Power Supply	Fuse Capacity	Minimum Circuit Ampacity	Maximum Overcurrent Protection
	V/Ph/Hz	A	A	A
TU18H3O	208V/230V ~60Hz	5	15.9	25
TU24H3O	208V/230V ~60Hz	5	23.4	40
TU30H3O	208V/230V ~60Hz	5	23.4	40
TU36H3O	208V/230V ~60Hz	5	27.7	45
TU42H3O	208V/230V ~60Hz	5	29.7	50
TU48H3O	208V/230V ~60Hz	5	36.5	60

**Notes:**

- ①. The fuse is located on the main board.
- ②. Install the disconnect device with a contact gap of at least 3mm (1/8inch) in all poles nearby the units (Both indoor unit and outdoor unit).The appliance must be positioned so that the plug is accessible.
- ③. Take 2 pieces of power cord of 0.75mm<sup>2</sup> (AWG18) as the communication lines between indoor and outdoor unit, with their longest lengths of 50m (164feet). Please select the appropriate line length as per the actual installation

conditions. The communication lines can not be twisted together. For the unit ( $\leq 30k$ ), it's recommended to use 8m (26-1/4feet) long communication line.

- ④. Take 2 pieces of power cord of  $0.75\text{mm}^2$  (AWG18) as the communication lines between the wired controller and the indoor unit, with their longest lengths of 30m (98-2/5feet). Please select the appropriate line length as per the actual installation conditions. The communication lines can not be twisted together. It's recommended to use 8m (26-1/4feet) long communication line.
- ⑤. The wire size of the communication line should be no less than  $0.75\text{mm}^2$  (AWG18). It's recommended to take  $0.75\text{mm}^2$  (AWG18) power cords as the communication line.

## 4 Installation of the Unit

### 4.1 Installation of the Indoor Unit

#### 4.1.1 Indoor unit dimension

<b>⚠WARNING</b>	
①.	Install the indoor unit in a location which can withstand a load of at least five times the weight of the main unit and which will not amplify sound or vibration.
②.	If the installation location is not strong enough, the indoor unit may fall and cause injuries.
③.	If the job is done with the panel frame only, there is a risk that the unit will come loose. Please take care.

For the units: 18k

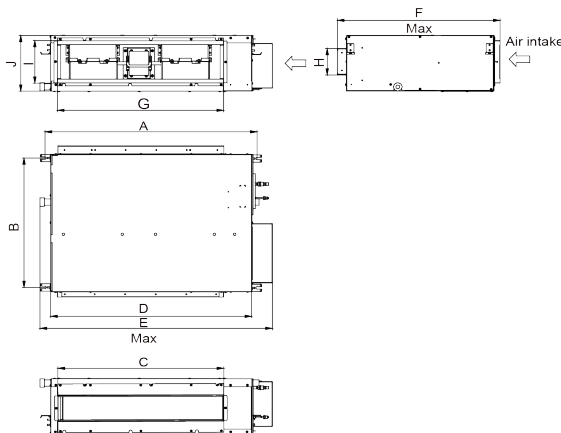

For the units: 24k~42k

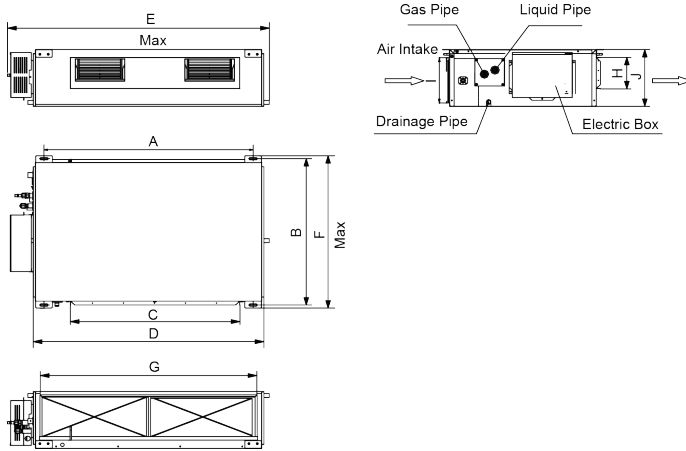

For the units: 48k

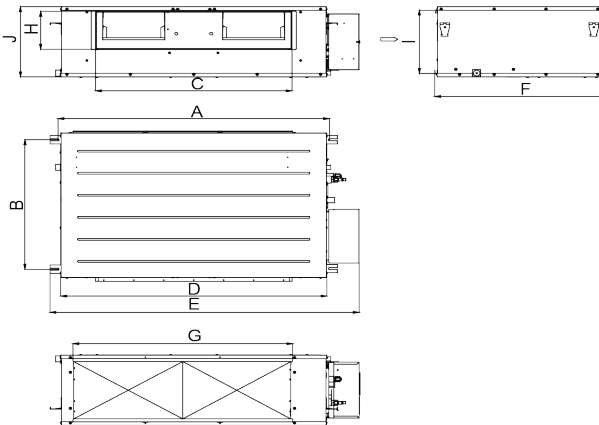

Fig. 4.1  
Table 4.1

Unit: mm (inch)

Item Model	A	B	C	D	E	F	G	H	I	J
TU18HFI	945 (37-1/4)	620 (24-3/8)	740 (29)	890 (35-1/8)	1035 (40-7/8)	720 (28-3/8)	740 (29)	125 (4-7/8)	205 (8)	265 (10-1/2)
TU24HFI	1100 (43-3/8)	515 (20-3/8)	820 (32-1/4)	1160 (45-5/8)	1280 (50-3/8)	560 (22)	1000 (39-1/2)	160 (6-1/4)	235 (9-1/4)	270 (10-1/2)
TU30HFI										
TU36HFI	1010 (39-3/4)	750 (29-1/2)	820 (32-1/4)	1115 (43-7/8)	1225 (48-1/4)	775 (30-1/2)	980 (38-1/2)	160 (6-1/4)	230 (9-1/8)	290 (11-3/8)
TU42HFI										
TU48HFI	1170 (46-3/8)	645 (25-3/8)	850 (33-1/2)	1150 (45-1/4)	1340 (52-3/4)	750 (29-1/2)	950 (37-1/2)	190 (7-1/2)	315 (12-1/2)	350 (13-3/4)



## 4.1.2 Drilling Holes for Bolts and Installing the Bolts

Using the installation template, drill holes for bolts (four holes) (Fig. 4.2).

## 4.1.3 Installing the Suspension Bolts

- (1). Install the bolts to the ceiling at a place strong enough to hang the unit. Mark the bolt positions from the installation template. With a concrete drill, drill for 12.7mm (1/2inch) diameter holes (Fig. 4.3).
- (2). Insert the anchor bolts into the drilled holes, and drive the pins completely into the anchor bolts with a hammer (Fig. 4.4).
- (3). Install the hanger to the unit (Fig. 4.5).
- (4). Pass the unit hangers over the bolts installed to the ceiling and install the unit with the special nut (Fig. 4.6).

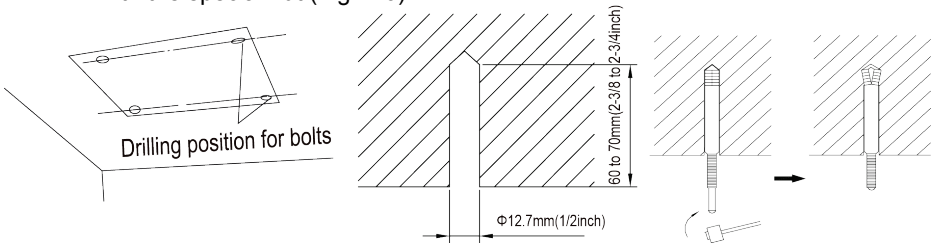

Fig.4.2

Fig.4.3

Fig.4.4

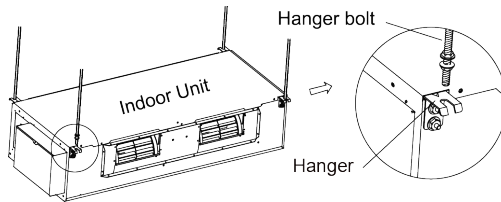

Fig.4.5

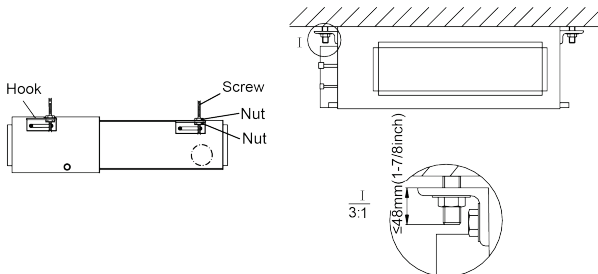

Fig.4.6

### 4.1.4 Leveling

The water level test must be done after installing the indoor unit to make the unit is horizontal, as shown below.

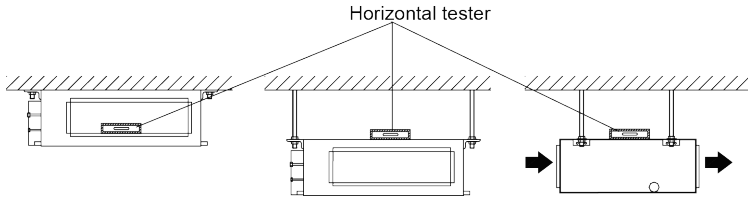

Fig. 4.7

## 4.2 Installation of the Outdoor Unit

### ⚠ WARNING

- ①. Install the unit where it will not be tilted by more than 5°.
- ②. During installation, if the outdoor unit has to be exposed to strong wind, it must be fixed securely.

### 4.2.1 Outdoor unit dimension

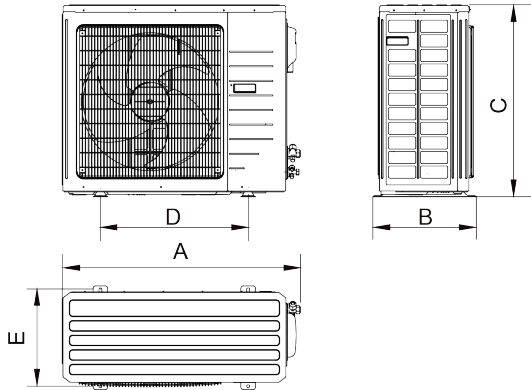

Fig. 4.8

Table 4.2

Unit: mm (inch)

Item	A	B	C	D	E
Model					
TU18H3O	955(37-5/8)	395(15-1/2)	700(27-1/2)	560(22)	360(14-1/8)
TU24H3O	980(38-5/8)	425(16-3/4)	790(31-1/8)	610(24)	395(15-1/2)
TU30H3O					
TU36H3O	1105(43-5/8)	440(17-3/8)	1100(43-1/4)	630(24-7/8)	400(15-3/4)
TU42H3O	960(37-3/4)	410(16-1/4)	1350(53-1/8)	570(22-1/2)	375(14-3/4)
TU48H3O					

## 4.2.2 Condensate Drainage of the Outdoor Unit (Only for the heat pump unit) (Fig. 4.9)

- (1). It is required to install a drain pipe for the outdoor unit to drain out the condensate water during heating operation (only for the heat pump unit).
- (2). When installing the drain pipe, apart from the drain pipe mounting hole, all other holes should be plugged so as to avoid water leakage (only for the heat pump unit).
- (3). Installation Method: Insert the pipe joint into the hole  $\Phi 25\text{mm}$  (1inch) located at the base plate of the unit and then connect the drain pipe to the pipe joint.

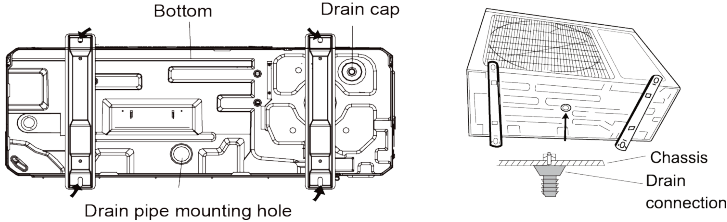

Fig. 4.9

## 4.3 Installation of the Connection Pipe

### 4.3.1 Flare Processing

- (1). Cut the connection pipe with the pipe cutter and remove the burrs.
- (2). Hold the pipe downward to prevent cuttings from entering the pipe.
- (3). Remove the flare nuts at the stop valve of the outdoor unit and inside the accessory bag of the indoor unit, then insert them to the connection pipe, after that, flare the connection pipe with a flaring tool.
- (4). Check if the flare part is spread evenly and there are no cracks (see Fig. 4.10).

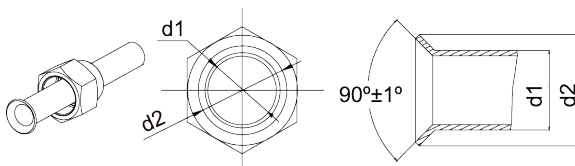

Fig. 4.10

### 4.3.2 Bending Pipes

- (1). The pipes are shaped by your hands. Be careful not to collapse them.

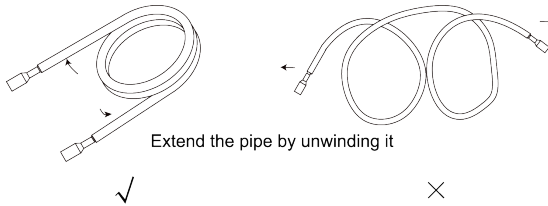

Fig. 4.11

- (2). Do not bend the pipes in an angle more than 90°.
- (3). When pipes are repeatedly bent or stretched, the material will harden, making it difficult to bend or stretch them any more. Do not bend or stretch the pipes more than three times.
- (4). When bending the pipe, do not bend it as is. The pipe will be collapsed. In this case, cut the heat insulating pipe with a sharp cutter as shown in Fig. 4.12, and bend it after exposing the pipe. After bending the pipe as you want, be sure to put the heat insulating pipe back on the pipe, and secure it with tape.

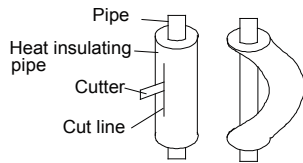

Fig. 4.12

#### ⚠ CAUTION

- |   |
|---|
| ①. To prevent breaking of the pipe, avoid sharp bends. Bend the pipe with a radius of curvature of 150mm (5-7/8inch) or over. |
| ②. If the pipe is bent repeatedly at the same place, it will break.   |

### 4.3.3 Connecting the Pipe at the Indoor Unit Side

Detach the caps and plugs from the pipes.

#### ⚠ CAUTION

- |  |
|--|
| ①. Be sure to apply the pipe against the port on the indoor unit correctly. If the centering is improper, the flare nut cannot be tightened smoothly. If the flare nut is forced to turn, the threads will be damaged. |
| ②. Do not remove the flare nut until the connection pipe is to be connected so as to prevent dust and impurities from coming into the pipe system.   |

Centering the pipe against port on the indoor unit turn the flare nut with your hand.

**CAUTION**

Hold the torque wrench at its grip, keeping it in the right angle with the pipe as shown in Fig. 4.13, in order to tighten the flare nut correctly.

When the flare nut is tightened properly by your hand, use a torque wrench to finally tighten it.

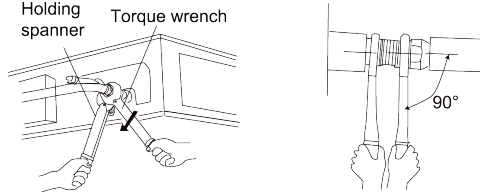

Fig. 4.13

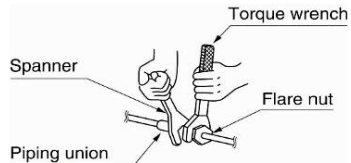
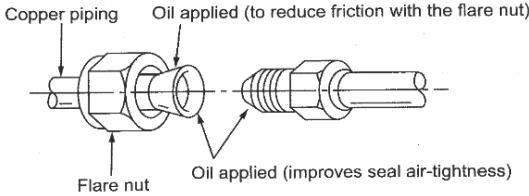

Fig. 4.14

Table 4.3 Flare nut tightening torque

Pipe Diameter	Tightening Torque
6mm (1/4inch)	15~30N·m (11~22ft.-1b.)
9.5mm (3/8inch)	35~40N·m (26~29ft.-1b.)
12.7mm (1/2inch)	45~50N·m (33~37ft.-1b.)
16mm (5/8inch)	60~65N·m (44~48ft.-1b.)

**CAUTION**

Be sure to connect the gas pipe after connecting the liquid pipe completely.

4.3.4 Connecting the Pipe at the Outdoor Side Unit

Tighten the flare nut of the connection pipe at the outdoor unit valve connector. The tightening method is the same as that as at the indoor side.

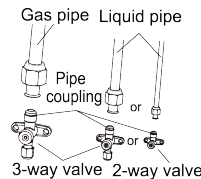

Fig. 4.15

### 4.3.5 Checking the Pipe Connections for Gas Leaking

For both indoor and outdoor unit side, check the joints for gas leaking by the use of a gas leakage detector without fail when the pipes are connected.

### 4.3.6 Heat Insulation on the Pipe Joints (Indoor Side Only)

Stick coupler heat insulation (large and small) to the place where connecting pipes.

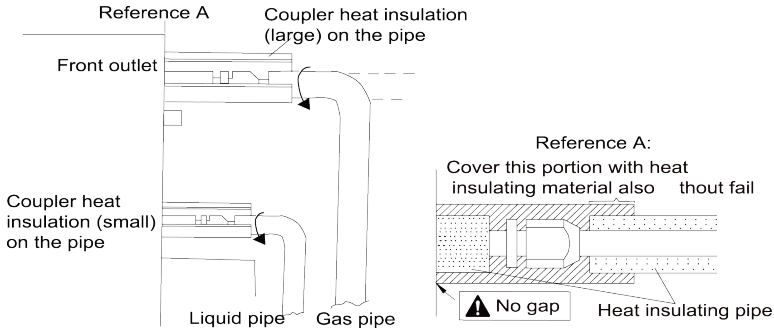

Fig. 4.16

### 4.3.7 Liquid Pipe and Drain Pipe

- (1). If the outdoor unit is installed lower than the indoor unit (See Fig. 4.17)
  - 1). A drain pipe should be above ground and the end of the pipe does not dip into water. All pipes must be restrained to the wall by saddles.
  - 2). Taping pipes must be done from bottom to top.
  - 3). All pipes are bound together by tape and restrained to wall by saddles.

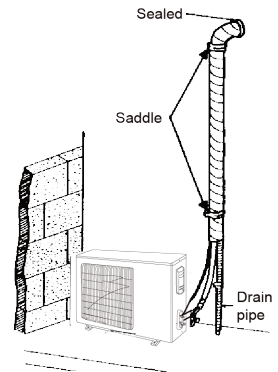

Fig. 4.17

- (2). If the outdoor unit is installed higher than the indoor unit (See Fig. 4.18)
  - 1). Taping should be done from lower to the upper part.
  - 2). All pipes are bound and taped together and also should be trapped to prevent water from returning to the room.
  - 3). Restraint all pipes to the wall with saddles.

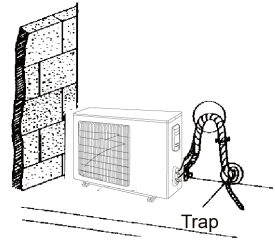

Fig. 4.18

## 4.4 Vacuum and Gas Leakage Inspection

### ⚠ CAUTION

Do not purge the air with refrigerants but use a vacuum pump to vacuum the installation! There is no extra refrigerant in the outdoor unit for air purging!

### 4.4.1 Vacuum

- (1). Remove the caps of the liquid valve, gas valve and also the service port.
- (2). Connect the hose at the low pressure side of the manifold valve assembly to the service port of the unit's gas valve, and meanwhile the gas and liquid valves should be kept closed in case of refrigerant leak.
- (3). Connect the hose used for evacuation to the vacuum pump.
- (4). Open the switch at the lower pressure side of the manifold valve assembly and start the vacuum pump. Meanwhile, the switch at the high pressure side of the manifold valve assembly should be kept closed, otherwise evacuation would fail.
- (5). The evacuation duration depends on the unit's capacity, generally, 20 minutes for the 18k units, 30 minutes for the 24k/30k/36k units, 45 minutes for the 42k/48k units. And verify if the pressure gauge at the low pressure side of the manifold valve assembly reads  $-1.0\text{MPa}$  (145psig), if not, it indicates there is leak somewhere. Then, close the switch fully and then stop the vacuum pump.
- (6). Wait for some time to see if the system pressure can remain unchanged, 3 minutes for the 18k/24k units, 10 minutes for the 30k/36k/42k/48k units. During this time, the reading of the pressure gauge at the low pressure side can not be larger than  $0.005\text{MPa}$  (0.72psig).
- (7). Slightly open the liquid valve and let some refrigerant go to the connection pipe to balance the pressure inside and outside of the connection pipe, so that

air will not come into the connection pipe when removing the hose. Note that the gas and liquid valve can be opened fully only after the manifold valve assembly is removed.

- (8). Place back the caps of the liquid valve, gas valve and also the service port.

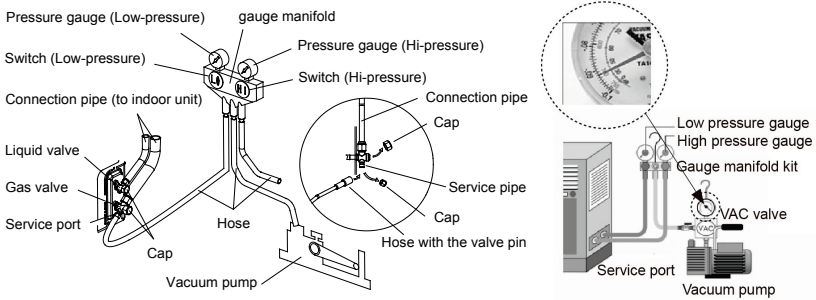

Fig. 4.19

**Note:** For the large-sized unit, it has the service port for both the gas valve and the liquid valve. During evacuation, it is available to connect two hoses of the manifold valve assembly to two service ports to quicken the evacuating speed.

### 4.4.2 Additional Charge

Refrigerant suitable for a piping length of 7.6m (25feet) is charged in the outdoor unit at the factory. When the piping is longer than 7.6m (25feet), additional charging is necessary.

For the additional amount, see Table 4.4.

Table 4.4

Model \ Item	Additional Refrigerant Amount for Extra Pipe
18k	45g per 1.5m (1.6 ounce per 5 feet )
24k~48k	90g per 1.5m (3.2 ounce per 5 feet )



When the height difference between the indoor unit and outdoor unit is larger than 10m (32-4/5feet), an oil bend should be employed for every 6m (19-2/3 feet).

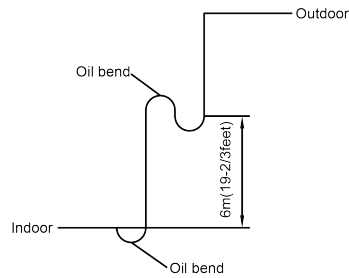

Fig. 4.20

## 4.5 Installation of the Drain Hose

- (1). It is not allowed to connect the condensate drain pipe into waste pipe or other pipelines which are likely to produce corrosive or peculiar smell to prevent the smell from entering indoors or corrupt the unit.
- (2). It is not allowed to connect the condensate drain pipe into rain pipe to prevent rain water from pouring in and cause property loss or personal injury.
- (3). Condensate drain pipe should be connected into special drain system for air conditioner.

### 4.5.1 Installation of Drain Piping

#### ⚠ CAUTION

Install the drain hose in accordance with the instructions in this installation manual and keep the area warm enough to prevent condensation. Problems with the piping may lead to water leaks.

- (1). Install the drain hose with downward gradient (1/50 to 1/100) and no risers or traps are used for the hose (Fig. 4.21).
- (2). Be sure there is no crack or leak on the drain hose to avoid the formation of air pocket (Fig. 4.21).
- (3). When the hose is long, install supporters (Fig. 4.22).
- (4). Always use the drain hose which has been insulated properly.

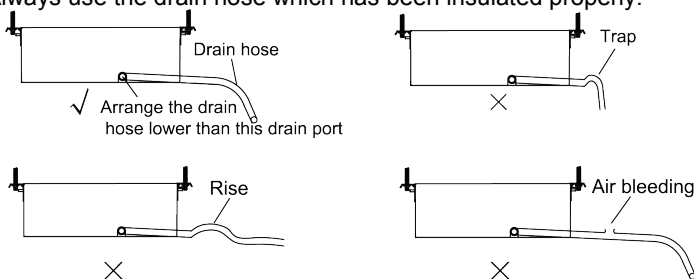

Fig. 4.21

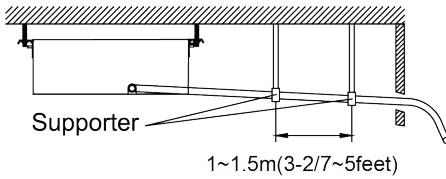

Fig. 4.22

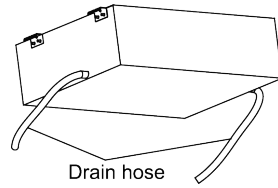

Fig. 4.23

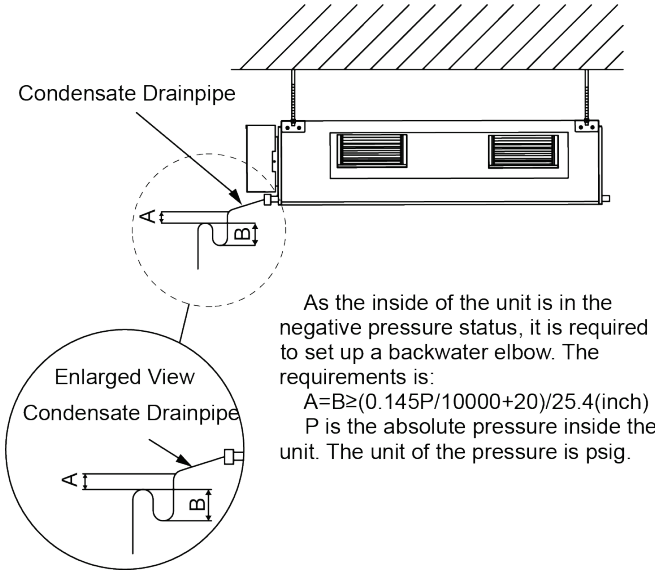

Fig. 4.24

- (5). Use a suitable drain hose, and see Table 3.3 for its size.
- (6). There is a drain port on both the left and right sides. Select the drain port to match the local conditions (Fig. 4.23).
- (7). When the unit is shipped from the factory, the drain port is defaulted to be the one on the left side (electric box side), the port on right side has been plugged.
- (8). When using the drain port on the right side of the unit, reinstall the drain cap to the left side drain port (Fig. 4.25).

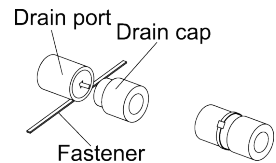

Fig. 4.25

**⚠ CAUTION**

Always check that the drain cap is installed to the unused drain port and is fastened with the nylon fastener. If the drain cap is not installed, or is not sufficiently fastened by the nylon fastener, water may drip during the cooling operation.

- (1). Be sure to insulate where the drain port and the drain hose is connected (Fig. 4.26).
- (2). The unused drain port also should be insulated properly (Fig. 4.27).

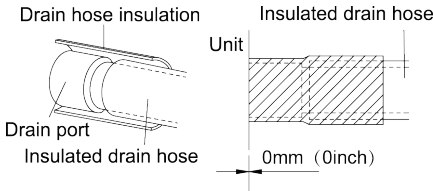

Fig. 4.26

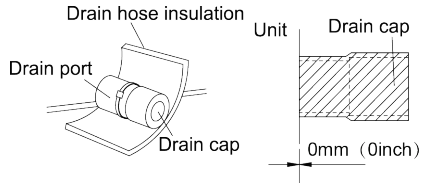

Fig. 4.27

- (3). There is adhesive on one side of the insulation so that after removing the protective paper over it the insulation can be directly attached to the drain hose.
- (4). Considerations for the unit with the condensate pump:
  - 1). For the unit with the condensate pump, only one drain port at the side close to the electric box is prepared and only through it the drain hose can be connected.
  - 2). See Table 3.3 for the size of the drain port of the unit with the condensate pump, which is different from that of the unit without the condensate pump.
  - 3). For the unit with the condensate pump, two drain ports at the bottom are defaulted to be factory plugged with drain caps. After the installation of the drain hose, these two drain ports also need to be insulated properly with the same way aforementioned.
  - 4). The drain hose for the unit with the condensate pump should be arranged as shown in the figure below.

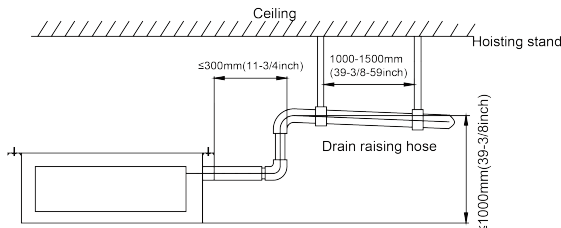

Fig. 4.28

- The vertical height of the drain hose should be 75mm (3inch) or less so that it is unnecessary for the drain port to withstand additional force.

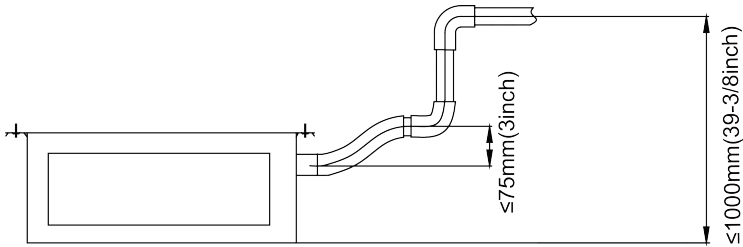

Fig. 4.29

- When multiple drain hoses are used, their installation should be performed as shown in the figure below.

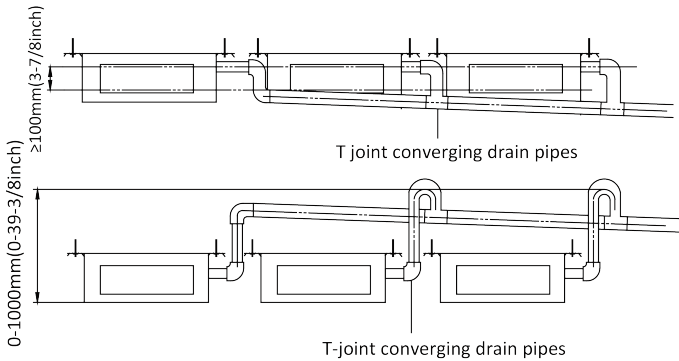

Fig. 4.30

## 4.5.2 Testing of Drain Piping

After piping work is finished, check if drainage flows smoothly.

As shown in the figure, add approximately 1 liter of water slowly into the drain pan and check drainage flow during COOL running.

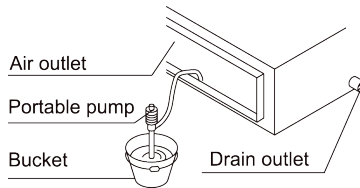

Fig. 4.31

## 4.6 Installation of the Duct

### 4.6.1 Dimensions of the Supply Air Outlet/Return Air Inlet

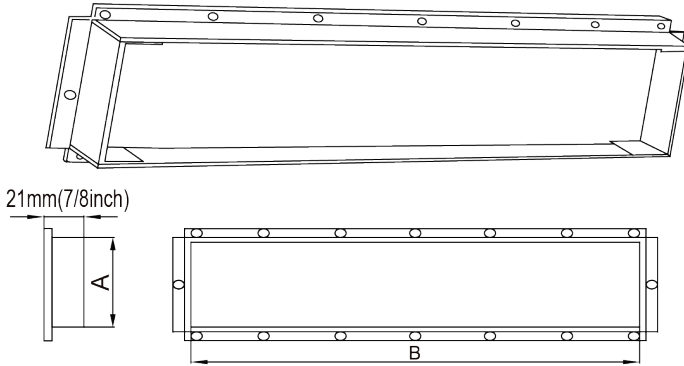

Fig. 4.32 Supply Air Outlet

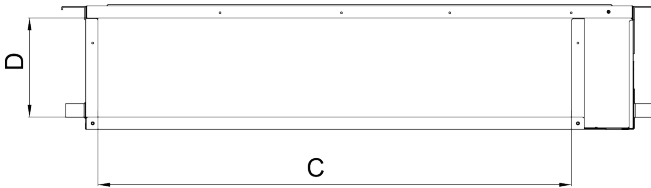

Fig. 4.33 Return Air Inlet

Table 4.5

Unit: mm (inch)

Model \ Item	Supply Air Outlet		Return Air Inlet	
	A	B	C	D
TU18HFI	123(4-7/8)	736(29)	710(28)	166(6-1/2)
TU24HFI	158(6-1/4)	818(32-1/4)	994(39-1/8)	195(7-5/8)
TU30HFI	158(6-1/4)	818(32-1/4)	994(39-1/8)	195(7-5/8)
TU36HFI	158(6-1/4)	818(32-1/4)	1000(39-3/8)	206(8-1/8)
TU42HFI	158(6-1/4)	818(32-1/4)	1000(39-3/8)	206(8-1/8)
TU48HFI	190(7-1/2)	850(33-1/2)	940(37)	286(11-1/4)

### 4.6.2 Installation of the Supply Air Duct

(1). Installation of the Rectangular Duct.

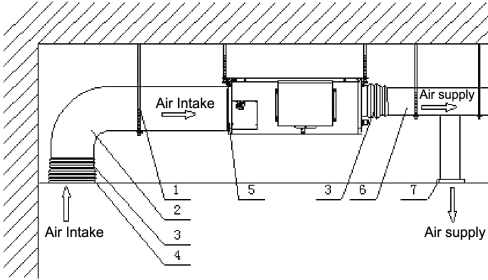

Fig. 4.34

Table 4.6 Installation of the rectangular duct

No.	Name	No.	Name
1	Hanger	5	Filter
2	Air Intake Pipe	6	Main Air Supply Pipe
3	Canvas Air Pipe	7	Air Supply Outlet
4	Air Intake		

<b>⚠ CAUTION</b>	
①.	The maximum length of the duct means the maximum length of the supply air duct plus the maximum length of the return air duct.
②.	The duct is rectangular and connected with the air inlet/outlet of the indoor unit. Among all supply air outlets, at least one should be kept open.

Bottom Return Air Installation only for the 18k Units.

- (2). The default installation location of the rectangular flange is at the back and the return air cover plate is at the bottom, as shown in Fig. 4.35.

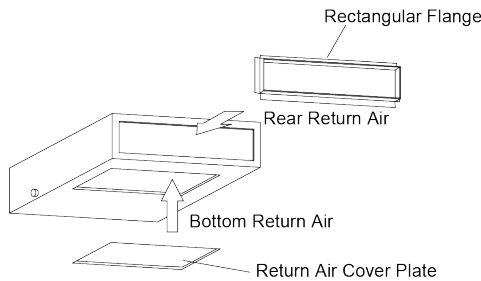

Fig. 4.35

- (3). If the bottom return air is desired, just change the place of the rectangular flange and the return air cover plate.
- (4). Connect one end of the return air duct to the return air outlet of the unit by rivets and the other to the return air louver. For the sake of the convenience to freely adjust the height, a cutting of canvas duct will be helpful, which can be reinforced and folded by 8# iron wire.

- (5). More noise is likely to be produced in the bottom return air mode than the backward return air mode, so it is suggested to install a silencer and a static pressure box to minimize the noise.
- (6). The installation method can be chosen with considering the conditions of the building and maintenance etc, as shown in Fig. 4.36.

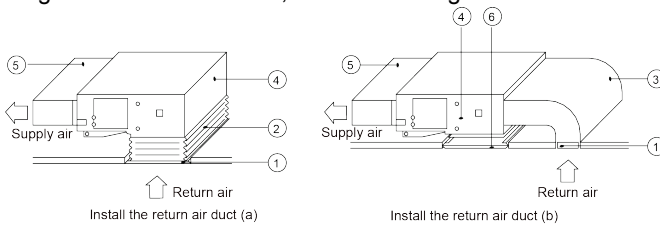

Fig. 4.36

Table 4.7 Installation of the return air duct

No.	Name	No.	Name
1	Return Air Inlet (with filter)	4	Indoor unit
2	Canvas Duct	5	Supply Air Duct
3	Return Air Duct	6	Grille

## 4.7 Electrical Wiring

### 4.7.1 Wiring Precautions

<b>⚠ WARNING</b>	
①.	Before obtaining access to terminals, all supply circuits must be disconnected.
②.	The rated voltage of the unit is as shown as Table 3.4 and Table 3.5.
③.	Before turning on, verify that the voltage is within the 187~252V range (for single phase units).
④.	Always use a special branch circuit and install a special receptacle to supply power to the air conditioner.
⑤.	Use a special branch circuit breaker and receptacle matched to the capacity of the air conditioner.
⑥.	The special branch circuit breaker is installed in the permanent wiring. Always use a circuit that can trip all the poles of the wiring and has an isolation distance of at least 3mm (1/8inch) between the contacts of each pole.
⑦.	Perform wiring work in accordance with standards so that the air conditioner can be operated safely and positively.
⑧.	Install a leakage special branch circuit breaker in accordance with the related laws and regulations and electric company standards.

**⚠ CAUTION**

- ①. The power source capacity must be the sum of the air conditioner current and the current of other electrical appliances. When the current contracted capacity is insufficient, change the contracted capacity.
- ②. When the voltage is low and the air conditioner is difficult to start, contact the power company to raise the voltage.

## 4.7.2 Electrical Wiring

(1). For solid core wiring (Fig. 4.37)

- 1). Cut the wire end with a wire cutter or wire-cutting pliers, then strip the insulation about 25mm (1inch).
- 2). Using a screwdriver, remove the terminal screw(s) on the terminal board.
- 3). Using pliers, bend the solid wire to form a loop suitable for the terminal screw.
- 4). Shape the loop wire properly, place it on the terminal board and tighten securely with the terminal screw using a screwdriver.

(2). For strand wiring (Fig. 4.37)

- 1). Cut the wire end with a wire cutter or wire-cutting pliers, then strip the insulation about 10mm (3/8inch).
- 2). Using a screwdriver, remove the terminal screw (s) on the terminal board.
- 3). Using a round terminal fastener or pliers, securely clamp a round terminal to each stripped wire end.
- 4). Position the round terminal wire, and replace and tighten the terminal screw with a screwdriver (Fig. 4.38).

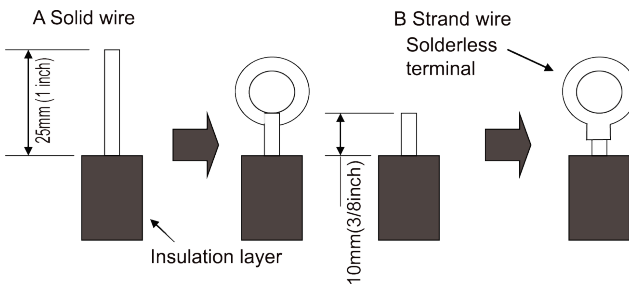

Fig. 4.37



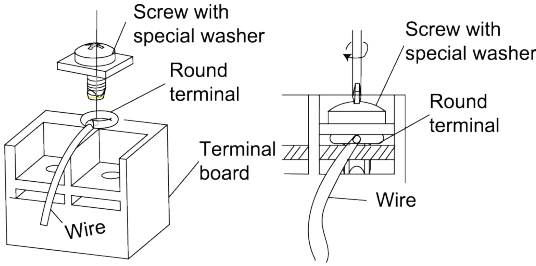

Fig. 4.38

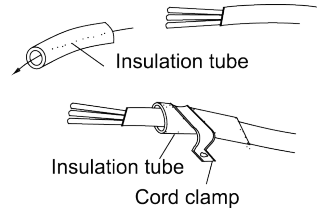

Fig. 4.39

(3). How to fix connection cord and power cord by cord clamp

After passing the connection cord and power cord through the insulation tube, fasten it with the cord clamp (Fig. 4.39).

**⚠ WARNING**

- ①. Before starting work, check that power is not being supplied to the indoor unit and outdoor unit.
- ②. Match the terminal block numbers and connection cord colors with those of the indoor unit side. Erroneous wiring may cause burning of the electric parts.
- ③. Connect the connection cords firmly to the terminal block. Imperfect installation may cause a fire.
- ④. Always fasten the outside covering of the connection cord with cord clamps. (If the insulator is not clamped, electric leakage may occur.)
- ⑤. Always connect the ground wire.

(4). Electric wiring between the indoor and outdoor units

Single-phase units (18k-30k)

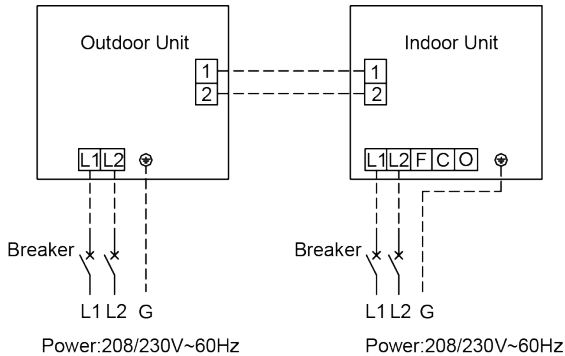

Single-phase units (36k-48k)

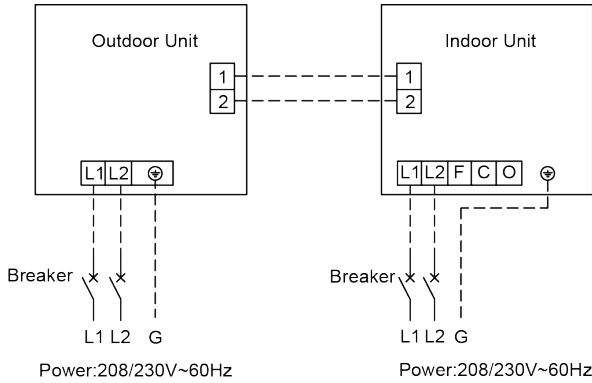

Fig. 4.40

(5). Electric wiring of indoor unit side

Remove the electric box cover from the electric box sub-assy and then connect the wire.

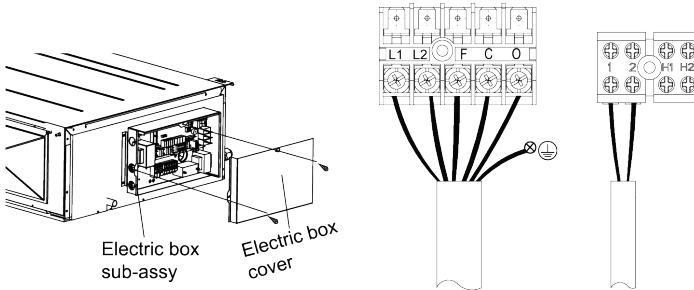

Fig. 4.41

The F, C, O connect to the COMMOM, CLOSE and OPEN terminal of the fresh air valve respectively.

**⚠ CAUTION**

- ①. The power cord and the wire of the fresh air valve are high-voltage, while the communication cord and connection wire of the wired controller are low-voltage. They should run separately against electromagnetic interference.
- ②. The high-voltage and low-voltage lines should pass through the rubber rings at different electric box covers.
- ③. Do not bundle the connection wire of the wired controller and the communication cord together, or arrange them in parallel, otherwise improper operation would occur.

**⚠ CAUTION**

- ④. The high-voltage and low-voltage lines should be fixed separately and securely, with internal big clamps for the former and small clamps for the latter.
- ⑤. Tighten the indoor/outdoor connection cord and power cord respectively on the terminal boards with screws. Faulty connection may cause a fire.
- ⑥. If the indoor unit connection cord (to the outdoor unit) and power supply are wired incorrectly, the air conditioner may be damaged.
- ⑦. Connect the indoor unit connection cord properly based on the corresponding marks as shown in Fig. 4.40.
- ⑧. Ground both the indoor and outdoor units by attaching a ground wire.
- ⑨. Unit shall be grounded in compliance with the applicable local and national codes.

(6). Electric wiring of outdoor unit side

**NOTICE!** When connecting the power supply cord, make sure that the phase of the power supply matches with the exact terminal board. If not, the compressor will rotate reversely and run improperly.

Remove the big handle (18k~30k) /front board (36k~48k) of the outdoor unit and insert the end of the communication cord and the power cable into the terminal board.

Single phase:

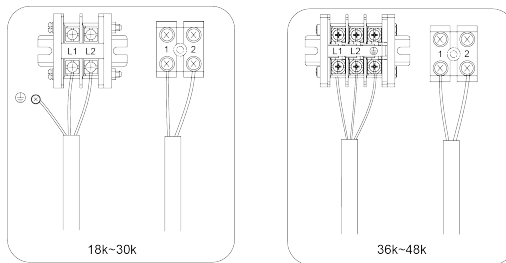

Fig. 4.42

Power lines should go along the right side plate. Communication lines between indoor and outdoor units also should go along the right side plate and keep away from power lines.

## 5 Installation of Controllers

Refer to the Installation Manual of the controller for more details.

## 6 Test Running

### 6.1 Trial Operation and Testing

(1). The meaning of error codes as shown below:

Table 6.1

Number	Error code	Error	Remarks
1	E1	Compressor high pressure protection	
2	E2	Indoor anti-freeze protection	
3	E3	Compressor low pressure protection, refrigerant lack protection and refrigerant colleting mode	
4	E4	Compressor high discharge temperature protection	
5	E6	Communication error	
6	E8	Indoor fan motor error	
7	E9	Full water protection	
8	F0	Indoor ambient temperature sensor error	
9	F1	Evaporator temperature sensor error	
10	F2	Condenser temperature sensor error	
11	F3	Outdoor ambient temperature sensor error	
12	F4	Discharge temperature sensor error	
13	F5	Temperature sensor error of wired controller	
14	C5	Capacity code error	
15	EE	Outdoor memory chip error	
16	PF	Electric box sensor error	
17	H3	Compressor overload protection	
18	H4	Overloading	
19	H5	IPM protection	
20	H6	DC fan motor error	
21	H7	Drive desynchronizing protection	
22	HC	PFC protection	
23	Lc	Activation failure	
24	Ld	Compressor phase sequence protection	
25	LE	Compressor stalling protection	
26	LF	Power protection	
27	Lp	Indoor and outdoor mismatch	

Number	Error code	Error	Remarks
28	U7	4-way valve direction changing protection	
29	P0	Drive reset protection	
30	P5	Over-current protection	
31	P6	Communication error between main control and drive	
32	P7	Drive module sensor error	
33	P8	Drive module over temperature protection	
34	P9	Zero passage protection	
35	PA	AC current protection	
36	Pc	Drive current error	
37	Pd	Sensor connecting protection	
38	PE	Temperature drift protection	
39	PL	Bus low voltage protection	
40	PH	Bus high voltage protection	
41	PU	Charge loop error	
42	PP	Input voltage abnormality	
43	ee	Drive memory chip error	

**NOTICE!** When the unit is connected with the wired controller, the error code will be simultaneously shown on it.

(2). Instructions to the Error Indicating Lamps on the Panel of the Duct Type Unit.

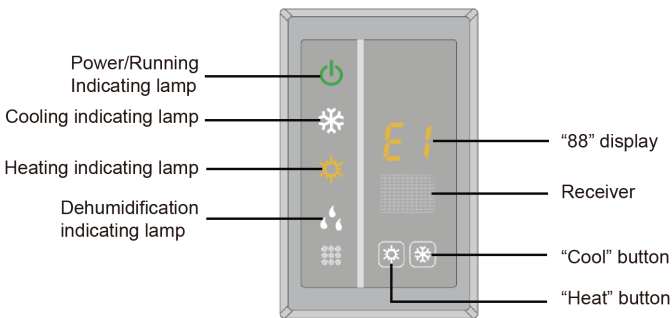

Fig. 6.1

## 6.2 Working Temperature Range

Table 6.2

Test Condition	Indoor Side		Outdoor Side	
	DB(°C/°F)	WB(°C/°F)	DB(°C/°F)	WB(°C/°F)
Nominal Cooling	26.7(80.0)	19.4(67.0)	35.0(95.0)	23.9(75.0)
Nominal Heating	21.1(70.0)	15.6(60.0)	8.33(47.0)	6.11(43.0)
Rated Cooling	26.7(80.0)	19.4(67.0)	46.1(115.0)	23.9(75.0)
Low Temp. Cooling	19.4(67.0)	13.9(57.0)	-18.0(0)	-
Rated Heating	26.7(80.0)	-	23.9(75.0)	18.3(65.0)
Low Temp. Heating	20.0(68.0)	-	-18.0(0)	-

### Notes:

- ①. The design of this unit conforms to the requirements of ARI 210/240-2008 standard.
- ②. The air volume is measured at the relevant standard external static pressure.
- ③. Cooling (heating) capacity stated above is measured under nominal working conditions corresponding to standard external static pressure. The parameters are subject to change with the improvement of products, in which case the values on nameplate shall prevail.

## 7 Unit Function

### 7.1 Setting of Double Indoor Room Sensors

This series of ducted air-conditioning unit has two indoor room sensors. One is located at the air intake of the indoor unit and the other one is located inside the wire controller.

User can select one from the two indoor room sensors on the basis of the engineering requirement.

(Refer to the section of wire controller instructions for detailed operation.)

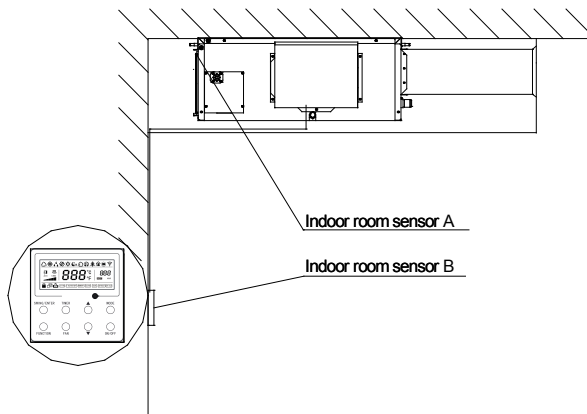

Fig. 7.1

### 7.2 Checking of Outdoor Ambient Temperature

The outdoor ambient temperature can be checked on the wire controller for the convenience of users before going out. (Refer to the section of wire controller instructions for detailed operation.)

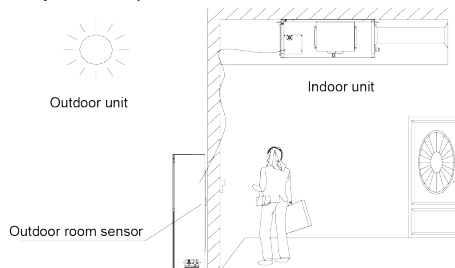

Fig. 7.2

## 7.3 Fresh Air Control

11-levels control can be realized for the amount of fresh air taken in. The function not only facilitates the health of users, but also controls the electricity consumption loss because of taking in fresh air. This kind of control can be carried out through the wire controller. The function can set at any time, goes into effect at any time, and features very simple operation. (Refer to the section of wire controller instructions for detailed operation.)

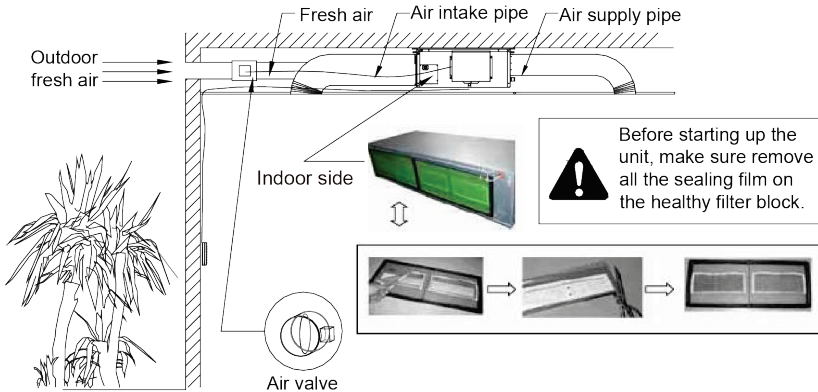

Fig. 7.3

## 8 Troubleshooting and Maintenance

### 8.1 Troubleshooting

If your air-conditioning unit suffers from abnormal operation or failure, please first check the following points before repair:

Failure	Possible Reasons
The unit cannot be started.	<ol style="list-style-type: none"> <li>①. The power supply is not connected.</li> <li>②. Electrical leakage of air-conditioning unit causes tripping of the leakage switch.</li> <li>③. The operating keys are locked.</li> <li>④. The control loop has failure.</li> </ol>
The unit operates for a while and then stops.	<ol style="list-style-type: none"> <li>①. There is obstacle in front of the condenser.</li> <li>②. The control loop is abnormal.</li> <li>③. Cooling operation is selected when the outdoor ambient temperature is above 46.1°C (115°F).</li> </ol>



Failure	Possible Reasons
Poor cooling effect.	①. The air filter is dirty or blocked. ②. There is heat source or too many people inside the room. ③. The door or window is open. ④. There is obstacle at the air intake or outlet. ⑤. The set temperature is too high. ⑥. There is refrigerant leakage. ⑦. The performance of room temperature sensor becomes worse.
Poor heating effect.	①. The air filter is dirty or blocked. ②. The door or window is not firmly closed. ③. The set room temperature is too low. ④. There is refrigerant leakage. ⑤. The outdoor ambient temperature is lower than -5°C (23°F). ⑥. Control loop is abnormal.

After carrying out the check of the above items and taking relevant measures to solve the problems found but the air-conditioning unit still does not function well, please stop the operation of the unit immediately and contact the local service agency designated by TOSOT. Only ask professional serviceman to check and repair the unit.

## 8.2 Routine Maintenance

Only a qualified service person is allowed to perform maintenance.

Before accessing to terminal devices, all power supply circuits must be disconnected.

Do not use water or air of 50°C (122°F) or higher for cleaning air filters and outside panels.

<b>NOTICE</b>	
①.	Do not operate the air conditioner with the filter uninstalled, otherwise dust would come into the unit.
②.	Do not remove the air filter except for cleaning. Unnecessary handling may damage the filter.
③.	Do not clean the unit with gasoline, benzene, thinner, polishing powder or liquid insecticide, otherwise it would cause discoloration and deformation of the unit.

**WARNING! Do not wet the indoor unit in case of electric shock or fire hazard.**

Increase the frequency of cleaning if the unit is installed in a room where the air is extremely contaminated. (As a yardstick for yourself, consider cleaning the filter once a half year.)

If dirt becomes impossible to clean, change the air filter. (Air filter for exchange is optional.)

- (1). Removing the air filter from the duct.
- (2). Cleaning the air filter.

Remove dust from the air filter using a vacuum cleaner and gently rinse them in cool water. Do not use detergent or hot water to avoid filter shrinking or deformation. After cleaning dry them in the shade.

18k:

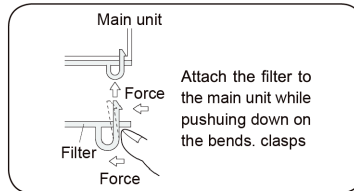
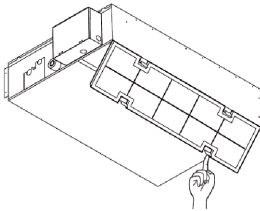

24k~48k:

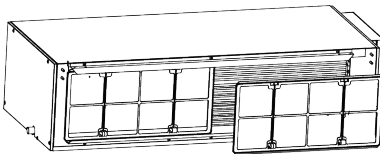

Press the return air inlet filter downward against the guide groove sponge and take it off along the arrow direction. There are two return air inlet filters.

- (3). Replacing the air filter Reinstall the filter as before.



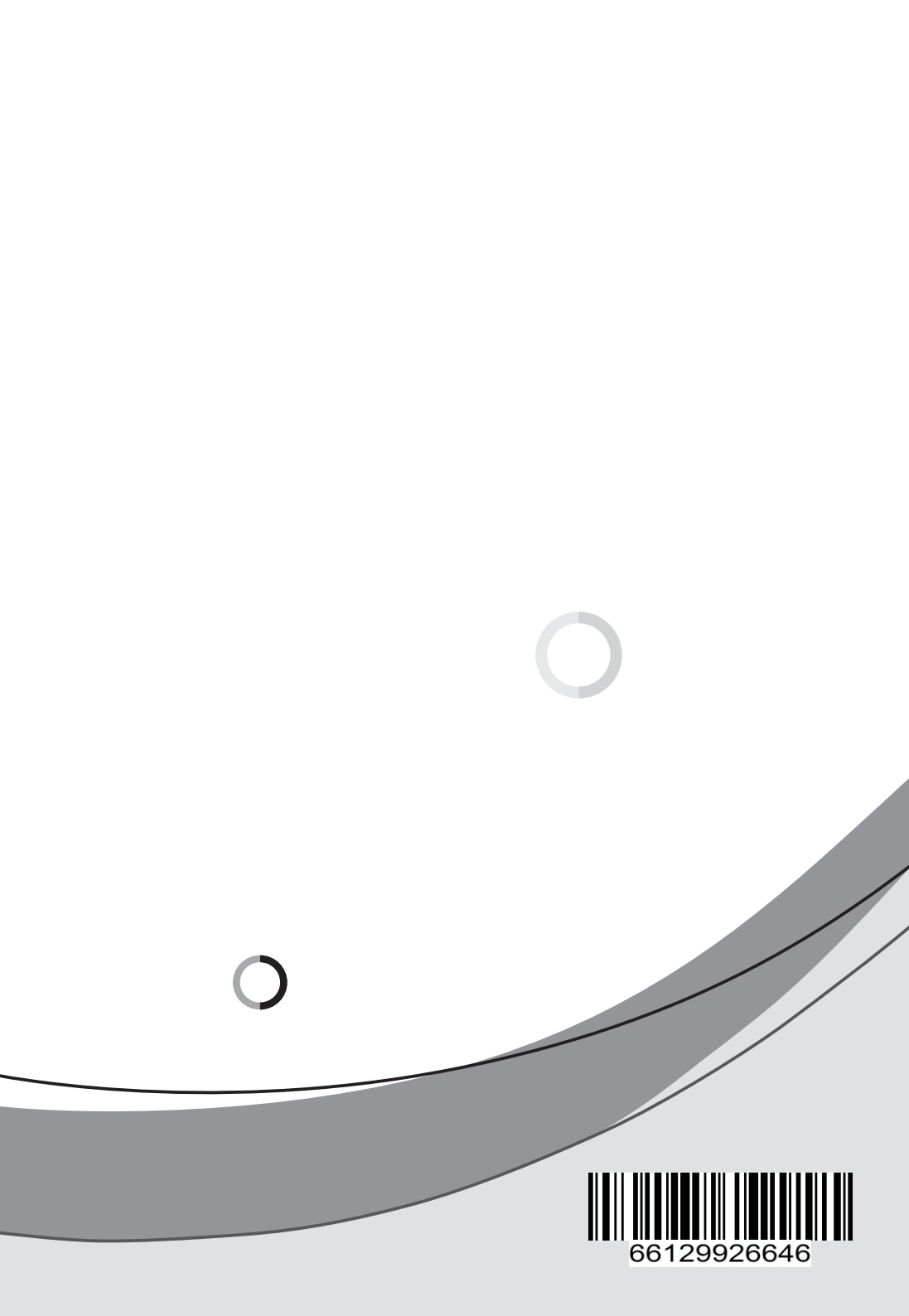

66129926646